



SHIVA EXPORTS

Importers of complete water management equipments



KAVERI IRRIGATIONS

IRRIGATION DESIGNERS & SUPPLIERS



PROFILE

@ ERODE – TAMILNADU

Registered office : 102,GOMUKHI POINT , EB complex back side, Sangu nagar
Collectorate post, Erode-638011, Tamilnadu, India.

Phone : 0424-2273033 / 2273032 Mobile :+91 99424 10700 /94875 10700 / 94433 60700

Email : sales@shiva-kaveri.com / ssivam5@vahoo.com / shivaexports3@vahoo.com

@ BANGALORE – KARNATAKA

Branch office : Maheshwaramma Temple Road , Maheshwari Nagar

Laxmi Sagar Layout , Mahadevapura , Bangalore-560048. Phone:+91 97399 25270

Email : bangalore@shiva-kaveri.com / projects@shiva-kaveri.com

@ CHENNAI – TAMILNADU

Branch office : 3/228 A , Rajeshwari St , Padmavathi Nagar ,

Jalladayan Pet ,Medavakkam ,Chennai-600100 Phone :+91 94443 61077, 88387 35498

Email : rain@shiva-kaveri.com / chennaishivakaveri@gmail.com,

@ HYDERABAD - TELANGANA

Branch office : C8W4+P44, Gopanapalli Thanda Primary School,

Hyderabad, Telangana 500019 Phone : +91 79995 01260 , 88387 35498

Email : ap@shiva-kaveri.com

@ DELHI

Branch office : Ground Floor No.B-135/5, Okhla Industrial Area , Phase I ,
New Delhi – 110020 Phone : 011-41090307 / 94433 60700

Email : sales@shiva-kaveri.com

IRRIGATION * SWIMMING POOL * WATER FEATURES * FOG SYSTEM * KOI POND
(DESIGN / CONSULTANCY / SUPPLY / PROJECT EXECUTION / AMC)



WEBSITE: WWW.SHIVA-KAVERI.COM

FOR SALES ENQUIRIES: +91 99420 10700

COMPANY'S PROFILE

BRIEF INTRODUCTION:

We started in the year 1996 with the sole purpose of providing efficient and economical irrigation system design and execution and giving water management products from across world with quality products and after sales service, to ensure optimum usage of available resources.

The Firm is capable to assure prompt design services and execution of works well conversant with modern technology in the field ideal to assert economy, speed and beautification, leed norms to be fit the need and preferences of aspirant customers.

The firm enjoys its vested formulation and planning modalities of optimum economy, workmanship and finishing apt to beautification as well as utilization.

OBJECTIVES:

- To ensure efficient usage of Water, Manpower and Machinery towards establishing and maintaining the greens cape of the land using Smart Irrigation technology.
- To ensure maximum value addition to the customers with enhancement.

FOUNDER OF SHIVA GROUP'S:

Mr. SADASIVAM MURUGAIYAN an B.E Agriculture Engineering Graduate from the prestigious TNAU- Coimbatore, he brings with him a Wealth of experience from Irrigation Industry. He has been associated with the industry in TAMILNADU , KARNATAKA & TELANGANA for the past 25 plus years in various capacities.

NATURE OF SERVICES :

- Design, Supply & Installation of Automated / Manual Pop-up turf and Golf Sprinkler Irrigation system for Lawn areas and Sports field.
- Design, Supply & Installation of Drip & Sprinkler Irrigation system for Agriculture, Horticulture & Plantation crops.
- Irrigation System installation & Maintenance Contracts.
- Consultancy for all types of irrigation requirements.
- Supply & Installation of Fountain Systems & Water Features.
- Rainwater Harvesting Techniques.
- Water feature design and execution (Electro- mechanical)
- Swimming pool design and execution (Electro mechanical)
- Using Smart Irrigation technology with Irrigation products.

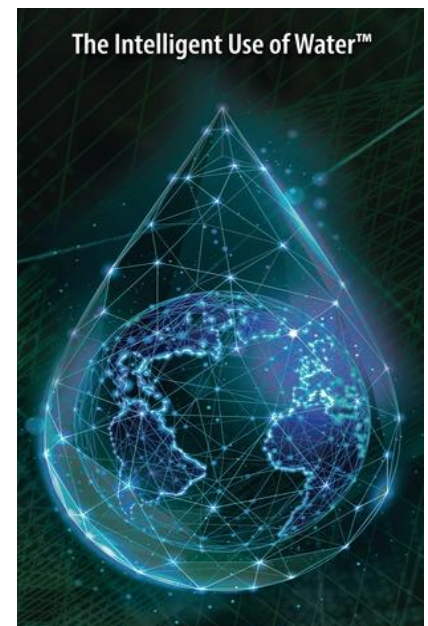

ASSOCIATION WITH BRANDS:

We have been associated with the best and leading brands of International market. This ensures Quality in products & services, and an efficient & trouble - free system leading to Customer satisfaction through latest Smart Irrigation Technology.

Some of the leading brands we associated with are:

- ❖ **M/s. RAINBIRD INTL INC.-USA (AUTHORISED SOUTH INDIA DISTRIBUTOR)**
- ❖ **M/s. AQVASTAR. - SINGAPORE - SWIMMING POOL PRODUCTS**
- ❖ **M/s. PIMTAS - TURKEY (AUTHORISED SELLER INDIA)**
- ❖ **M/s. ARMAS - TURKEY (AUTHORISED SELLER INDIA)**
- ❖ **M/s. WILO – GERMAN (AUTHORISED DEALER)**
- ❖ **M/s. SUPREME– MUMBAI(ASSOCIATED WITH AUTHORISED DISTRIBUTOR)**
- ❖ **M/s. VARIOS – VALVES, FOUNTAIN NOZZLES & LIGHTS - SINGAPORE**
- ❖ **M/s. ITALFOG – MIST PUMPS - ITALY**
- ❖ **M/s. XERITECH – INDIA**
- ❖ **M/s. KASCO – USA – AERATORS**

TEAM SETUP:

We have well experienced team setup of General Manager's with strong **Technical , Marketing & Administration knowledge** , Area Managers for **Sales** , Project Engineers for **Project Planning & Execution** , Technicians and 50 Trained Mechanics as Field Staff for project execution, apart from the Administrative Staff, Design Engineers who are well trained in **Design and executing the hi-tech Irrigation Products.**

We have our Registered office @ **Erode – Tamilnadu and its Branches @ Chennai , Bangalore , Hyderabad and Delhi.**

CUSTOMER SERVICE:

We believe in providing prompt response to all customers during or after completion of project. It supports customer for guaranteed period to ensure that the system runs efficiently year after year. The firm also enters into Annual Maintenance Contracts (AMC's) with various companies to provide guaranteed trouble free Operation for the Irrigation system.

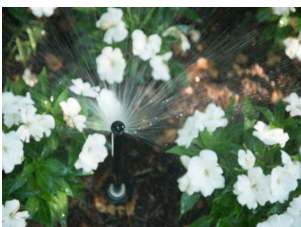

PRODUCTS:

IRRIGATION



SWIMMING POOL

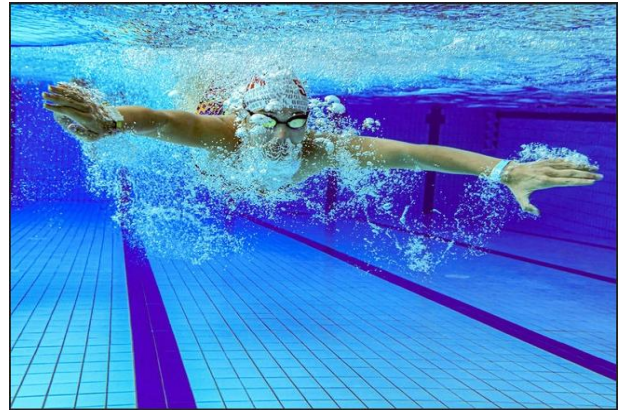

WATER FEATURES



FOG SYSTEM



KOI POND



- Pop-up Rotor Sprinklers & Spray heads.
- Solenoid Valves & Gate / Ball Valves.
- PVC pipes, Filters, Controllers for Automation
- Impact Sprinklers & Rain Gun Sprinklers
- Drippers & Micro Sprayers
- Lawn & Garden products
- Water feature nozzles and underwater lights
- Swimming pool equipment
- Water hammer arrestor
- Control valves

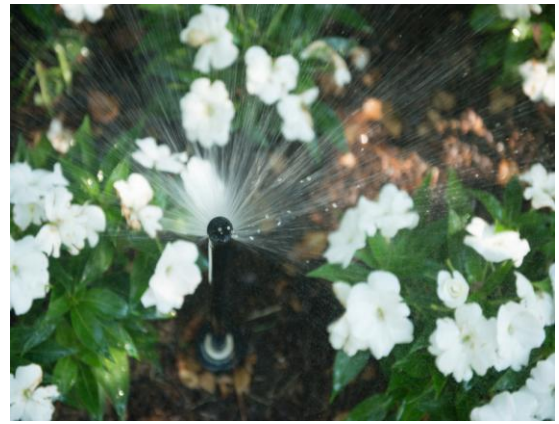

3500 Series	5000 Series	Falcon® 6504 Series	8005 Series
 <p>0.37 to 0.83 in/hr (9 to 21 mm/h)</p> <p>25 to 55 psi (1.7 to 3.8 bar)</p> <p>0.54 to 4.6 gpm (2.0 to 17.4 l/m) (0.12 to 1.04 m³/h)</p> <p>4" (10.2 cm) Shrub: 7" (17.8 cm) 4": 6 9/16" (16.8 cm) 1/2" (20/27) NPT</p>	 <p>0.20 to 1.01 in/hr (5 to 26 mm/h)</p> <p>25 to 65 psi (1.7 to 4.5 bar)</p> <p>0.76 to 9.63 gpm (3.0 to 36.6 l/m) (0.17 to 2.19 m³/h)</p> <p>Shrub: 4" (10.2 cm) 6" (15.2 cm)</p> <p>Shrub: 7 1/4" (19.7 cm) 4": 7 3/4" (19.8 cm) 6": 9 1/4" (24.5 cm) 3/4" (20/27) NPT</p> <p><i>down with Rain Bird® Rain Gun</i></p>	 <p>0.37 to 1.14 in/hr (9 to 29 mm/h)</p> <p>30 to 90 psi (2.1 to 6.2 bar)</p> <p>2.9 to 21.7 gpm (10.8 to 82.2 l/m) (0.66 to 4.93 m³/h)</p> <p>4" (10.2 cm) 8 1/2" (21.6 cm) 1" (26/34) NPT or BSP</p>	 <p>0.48 to 1.23 in/hr (12 to 31 mm/h)</p> <p>50 to 100 psi (3.5 to 6.9 bar)</p> <p>3.8 to 36.3 gpm (14.4 to 137.4 l/m) (0.86 to 8.24 m³/h)</p> <p>5" (12.7 cm) 10 9/16" (25.7 cm) 1" (26/34) NPT or BSP</p>





LIST OF PRESTIGIOUS IRRIGATION PROJECTS EXECUTED IN SOUTH INDIA AS FOLLOWED BELOW:

KARNATAKA	
Project Name - KARNATAKA	Year
Bangalore International Airport Limited- MAR FORECOURT Bangalore	2022
Bangalore International Airport Limited- ELEVATED WALKWAY, Bangalore	2022
Bagmane Developers Pvt. Ltd –Helium - Solarium City, Bangalore	2022
Bagmane Constellation- TAURUS 4 (Non-SEZ),Bangalore	2022
Bagmane Constellation- Arrival Court, Bangalore	2022
Bagmane Constellation- MPD, Bangalore	2022
Aparna Constructions And Estates Pvt.Ltd - Maple	2022
Frontline Builders , Bangalore	2022
GE India Industrial Pvt.Ltd , Bangalore	2022
Jones Lang LaSalle Property Consultants ,Shell , Bangalore	2022
Turf Care LLP – Cricket and Football Ground	2022
Bangalore International Airport Limited- FOA	2022
Bangalore International Airport Limited- Bells & Veils	2021
Bangalore International Airport Limited- MAR Phase III Bangalore	2021
Ecogreen Landscape Technologies Pvt.Ltd – BIAL -Polyhouse	2021
Bagmane Constellation- Rio, Bangalore	2021
Bagmane Constellation- Opal, Bangalore	2021
Bagmane Constellation- Xenon, Bangalore	2021
Bagmane Constellation- Quay, Bangalore	2021
Peacock Hospitals – Kiran Residency, Bangalore	2021
Bagmane Constellation- Crown, Bangalore	2021
ITC Limited, Bangalore	2021
Purvankara Limited – Sound of Water , Bangalore	2021
Roach Properties & Developers LLP – Olympus -Bangalore	2021
Prestige Estates Project. Pvt. Ltd – Kenilworth - Bangalore	2021
Bangalore International Airport Limited- MAR Phase I Bangalore	2020
J W Mariott – Bangalore (IGBC Project)	2020
Twenty Fourteen Hotels India Pvt Ltd - Bangalore	2020
GE - Bangalore (IGBC Project)	2020
Karle – Hub 4 - Bangalore	2020
Anil Haridhas Residency - Bangalore	2020

Project Name - KARNATAKA	Year
Coevolve – Northern Star -Bangalore	2020
Bagmane Constellation- Quay (Non-SEZ),Bangalore	2020
Bagmane Constellation- Parin (Non-SEZ),Bangalore	2020
Bagmane Constellation- WTC Upgradation (Non-SEZ),Bangalore	2020
Akash Commercial Developments - Bangalore	2020
Prestige Song of South – Bangalore	2020
Prestige Leela Residency – Bangalore	2020
Prestige Kenilworth – Bangalore	2020
Fire Remedy Systems - Bangalore	2020
Jayachamaraja Wadiyar Golf Club, Mysore	2019
Wipro Kodathi, Bangalore (IGBC Project)	2019
Infosys Mysore - (IGBC Project)	2019
Aparna Elina, Bangalore - (IGBC Project)	2018
Bagmane Constellation-Aquila (Non-SEZ),Bangalore	2018
Bagmane Capital Tech Park, Bangalore	2018
Bagmane Constellation- Tarus (Non-SEZ), Bangalore	2018
Bangalore International Airport Limited-Admin Block, Bangalore	2018
Bagmane Upgradation (Non-SEZ), Bangalore	2018
Bangalore International Airport Limited-Admin Block-Alpha-2 Bangalore	2018
Prestige West woods, Bangalore	2018
Mantri Lithos, Bangalore	2018
TKML ECO Zones, Bangalore	2018
Godrej SSPDL Green Acres LLP	2018
Molex New Plant, Bangalore	2018
Bank Note Paper Mill India PVT LD, Mysore	2018
ITC bangalore	2018
Ozone Groups- Ozone Pavilion Bangalore	2018
ROW Divya Sree	2018
Airport Retail Plaza	2018
Airport SWR Conativity Road	2018
BNPML Phase – II	2018
Embassy Boulevard Club House, Bangalore (IGBC Project)	2017
OSR Land & Avenue Road at Brigade Xanadu, Chennai	2017
Bidarkere Pond	2017
Malavalli pond	2017

Project Name - KARNATAKA	Year
Kothagere Pond,Kothagere	2017
Hosakere Pond	2017
The Lake View Address, Bangalore - (IGBC Project)	2017
Mahindra Wind Chimes	2017
Bangalore International airport ltd.	2017
ITC Info Tech Bangalore	2017
ITC Green Centre Bangalore	2017
Divyasree R.O.W projects LLP- Bangalore (IGBC Project)	2017
India build homes Pvt ltd Bangalore	2017
Capgemini Main Campus – Bangalore	2017
Aparna constructions and estates p ltd. Bangalore (IGBC Project)	2017
Birla House Cricket Ground – Bangalore	2017
GMR house – Bangalore	2017
Presidency University- Rajangunde Bangalore	2017
Embassy boulevard	2017
RMZ 4 C- - Bangalore - (IGBC Project)	2017
New Horizon college – Bangalore	2017
Toyoto Kirloskar motors Bidithi Bangalore	2017
RBD Shelters LLP – Bangalore	2017
Prabhu Farm House - Solur Bangalore	2017
Qualcomm – Bangalore - (IGBC Projectt)	2017
MTB - 03 – Bangalore	2017
Bcil Zed earth developers (India) P ltd – Bangalore	2017
Chikkere pond (Sadbhav Group) – Tumkuru	2017
Iyyangudi pond (Sadbhav Group) – Tumkuru	2017
Mr. Selvarasu Residency – Bangalore	2017
Mr. Ayuktha Residency – Bangalore	2017
Embassy Boulevard – Bangalore	2016
TAJ Hotel – Bangalore International Airport	2016
Bank Note Pvt Mill ltd –RBI	2016
Samskruti Builders – Bangalore	2016
Central Area Canon Circle- Bangalore International Airport	2016
Coorg Golf Links, Madikarai	2015
JWGC Golf Course, Mysore	2015
Mahendra Resort	2015

Project Name - KARNATAKA	Year
Karle Project, Bangalore	2015
Embassy Bolueward, Bangalore	2015
Huawei technologies, Bangalore	2014
Ahlu Walia Contacts (I) Ltd, Bangalore.	2013
Embassy Business Park, Bangalore.	2011
Ajmeera Housing, Bangalore.	2011
Century Developers, Bangalore.	2010
ITC Bangalore.	2007
Salary puria GR Tech Park, Bangalore.	2005
HINDUSTAN SERVICE CENTER Bangalore.	2005
TAMILNADU	
Project Name - TAMILNADU	Year
HCL Technologies Ltd, Chennai	2022
Manakula Vinayagar Engineering College, Pondicherry	2022
Infosys , Chennai	2022
GRT Hotels & Resorts Pvt.Ltd ,Chennai	2022
Purvankara Limited – Hibiscus , Coimbatore	2022
TVS SRICHAKRALTD , Madurai	2022
Ansell -Perundurai (IGBC Project)	2022
Peacock Hospitals- Tiruthani	2021
K Net solutions Chennai	2021
SKM Egg Products Exports India Pvt. Ltd Erode	2021
Brigade – Perungudi Real Estate Chennai (IGBC Project)	2020
WTC - Chennai (IGBC Project)	2020
L.S Mills - Theni (IGBC Project)	2020
KCP Engineers – Walangulam / Periyakulam Coimbatore	2020
Rajasekhar Residency - Rajapalayam	2020
Sundaram Residency - Tamilnadu	2020
Sivasami Residency - Karur	2020
Muthuraja Residency - Vellakovil	2020
Nirmal Residency - Tamilnadu	2020
TVS Showroom - Madurai	2020
Navamani Residency - Avinashi	2020
Smart City, Coimbatore	2018
OSR Land & Avenue Road at Brigade Xanadu, Chennai	2017
JC Alloys Perundurai SIPCOT	2016
TCS – Siruseri Sipcot – Navallur Chennai	2016

Project Name - TAMILNADU	Year
Wellington Golf Club – Kunnur	2016
Actor Surya Residence, Chennai	2015
OTA Office & Training Academy, Chennai	2015
Mahendra Resort	2015
HCL Phase 2, Chennai (IGBC Project)	2014
PRANA Resort, Chennai(ITC group)	2014
Dhanalakshmi Engineering College, Trichy	2014
Danfoss control systems, Chennai	2014
Sri Nachammal Vidyavani, Avinashi.	2013
Sakthi Masala Pvt Ltd , Mamarathupalayam ,	2013
Parkar Estate And Holding (P) Ltd, Salem.	2013
Paver Varam Educational Trust, Rasi Puram, Nammakkal.	2013
T.Murali, Viruthu Nagar.	2013
Dixcy Textiles Pvt Ltd, Tirupur.	2013
Adayar Gate Hotels Ltd, Chennai.	2013
Great Mount Resort (p) Ltd, Pollchi.	2012
Saveetha University , Chennai .	2012
Pallam Crave (HQ ATNK), Chennai.	2012
Rajasekar Spin Tex, Raja palayam.	2012
VIT University, Chennai.	2012
Mr. Vishnu, Salem.	2012
Mr. Periyannan, Erode.	2012
One World Academy, Chennai.	2012
Sangeeth Textiles Limited, Coimbatore.	2012
Kannan Department (Navaneetha Krishnan), Erode.	2012
Intra Tex, Perundurai.	2012
The Indian Public School, Erode.	2012
Yercaud Park, Salem.	2012
Genetic Park, Yercaud.	2012
DAIMLER COMMERCIAL VEHICLES LTD, Chennai.	2012
TOSHIBA JSW generators Ltd, Manali.	2011
Areva, Chennai.	2011
Allison Transmissions, Chennai.	2011
Sri Sugan International, Perundurai.	2011
BOSCH Software Park, Coimbatore.	2011
L And T Eden City, Chennai.	2011
Mr. Marans Residence, Chennai.	2011
SUN TV ,Corporate office, Chennai	2011

Project Name - TAMILNADU	Year
VIT University, Chennai.	2009
SNQS International, Tirupr.	2009
WIPRO, Chennai.	2009
RPP Constructions Erode.	2009
Asok Leyland, Cheyar.	2009
Tuticorin Port Trust, Tuticorin.	2009
Venkateswara College, Gobi.	2009
Ford India, Chennai.	2009
Infrtex , Eastman Exports, Perundurai.	2009
EID Parry, Pettaivaithalai ,	2009
MP HILTON, Chennai.	2009
Mahindra world City, Chennai.	2009
GKN drive line, Chennai.	2008
URC Constructions Pvt Ltd, Erode.	2008
Hitech Weaving Park, Palladam.	2008
Del Computers, Chennai.	2008
ITC Bangalore.	2007
ITC Bangalore.	2007
KGA Group, Cochin.	2007
Syntheses Group, Ramada inn, Cochin.	2007
Mahindra world City, Chennai.	2007
Auto Auto mobiles, Chennai.	2007
Summer India Exports.	2007
Banff Pharmaceuticals Co ltd, Chennai.	2007
World Bank , Chenn	2006
Aban Power Company ltd, Tanjore.	2006
Sri Nark Electronics, Chennai.	2005
Nethaji Apparel Park, Tirupur.	2005
Orchid Health Care, Chennai.	2004
AMUDHAM DAIRY (Taste me milk) Bhavam.	2004
KKP Resin, Namakkal.	2004
Dr .Sunny kurien , Aliva.	2004
KG DENIM Resi , Coimbatore.	2004
AD Textiles, Karur.	2003
KONGU Vellalar Institute of tech trust, Erode and Rise , Perundurai.	2003
KKSK Leathers Pvt ltd, Erode.	2001

Project Name - TAMILNADU	Year
PC motors , Erode.	2001
KSR Institutions, T.code.	1999
JANSON group of companies , T.code	1998
SKM group of Companies , Erode.	1997
AP & TELANGANA	Year
Project Name - AP & TELANGANA	Year
Aparna Constructions And Estates Pvt.Ltd – Altius , Hyderabad	2022
Aparna Constructions And Estates Pvt.Ltd – Cyber scape , Hyderabad	2022
Aparna Constructions And Estates Pvt.Ltd – Luxor park , Hyderabad	2022
Aparna Constructions And Estates Pvt.Ltd – Mall , Hyderabad	2022
Aparna Constructions And Estates Pvt.Ltd – One , Hyderabad	2022
Aparna Constructions And Estates Pvt.Ltd – Serenity , Hyderabad	2022
Divyashree Tec park constructions Pvt. Ltd – Tec ridge , Hyderabad	2022
Rajapushpha Properties Pvt Ltd – Guest House - Hyderabad	2022
Rajapushpha Properties Pvt Ltd – Eterna , Hyderabad	2022
Rajapushpha Properties Pvt Ltd – Imperia , Hyderabad	2021
Vasanth Narmatha Residency , Hyderabad	2021
Infosys, Hyderabad	2021
Sattava Knowledge Park , Hyderabad	2021
Wipro – Grotech - Hyderabad (IGBC Project)	2021
Pheonix Mall – Telangana - (IGBC Project)	2021
Bhakyanagar infra Projects – Marina Sky, Hyderabad	2021
Rajapushpa Properties Pvt Ltd – Paradigm , Hyderabad	2021
Nuclear Fuel Complex - Hyderabad	2020
SHIVA Villa Yadav - Hyderabad	2020
Aparna Zenith - Hyderabad - (IGBC Project)	2020
Laxmi Infotech – GAR site - (IGBC Project)	2020
Rajapushpha Properties Pvt Ltd – Summit - (IGBC Project)	2020
Rajapushpha Properties Pvt Ltd – Green dale - (IGBC Project)	2020
Prestige High field -Hyderabad - (IGBC Project)	2020
Infosys Pocharam - (IGBC Project)	2019
Vijayawada Municipal Corporation	2018
Rajahmundry Airport	2018
Aparna Serene Park, Hyderabad - (IGBC Project)	2018
Sunray Beach Resort – Vizag	2016
Rajapushpha Properties Pvt Ltd – Hyderabad	2016

Project Name - AP & TELANGANA	Year
Sri City	2016
JC Alloys Perundurair SIPCOT	2016
EPCG Golf club,VIZAG	2015
INFOSYS ,HYDERABAD	2015
Hyderabad golf association, Hyderabad	2015
SriCity Accom 2,TADA	2015
Aparna Group of Construction, Hyderabad (IGBC Project)	2015
K.S.Vengatraman & Co, Tada.	2012
KERALA	
Project Name - KERALA	Year
Chinnu's Residency, Kollam	2022
SunTec Park , Kerala	2022
Bhaju Mohammad Residency , Kollam	2021
Gokulam Resort, Kerala - (IGBC Project)	2019
Raheem Residence Nilambur, Kerala	2019
QASR Hotel Cochin Private Limited, Cochin	2018
Malayala Manoramma – Cochin	2016
Sudhakaran Nail & Company, Cochin.	2012
Lulu Shopping Mall, Cochin.	2012
Lulu Flight Kitchen, Cochin.	2012
KGA Group, Cochin.	2007
Syntheses Group, Ramada inn, Cochin.	2007
Project Name - OTHER STATES	Year
Vedanta Alumina ltd. Orissa.	2008
TCS, Bhubaneswar.	2008
Bharat Aluminum Co Ltd, Korba.	2006



OUR LATEST PRIDE 2022

**KEMPEGOWDA INTERNATIONAL AIRPORT – BENGALURU
– BELLS & VEILS PROJECT**

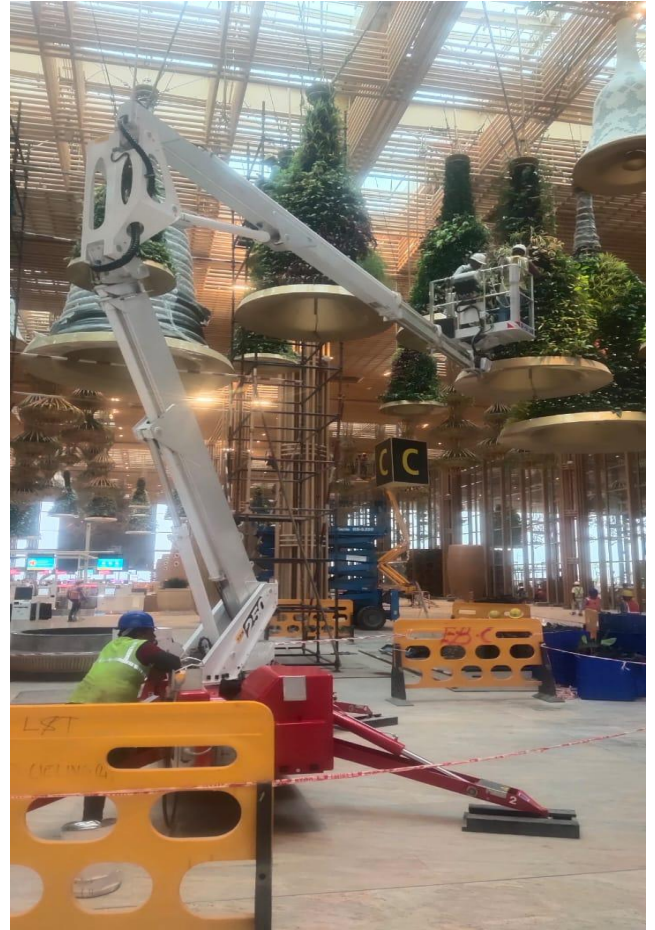

SMART TECHNOLOGY:

We are capable of prompt execution of work by utilizing Smart technology that ensures satisfied customers and recommend automation, which is a breakthrough in the field of irrigation, for the reasons of economy, simplicity, flexibility and dependability for past years.



The highlight of our company is associated with World-renowned Rain Bird smart Irrigation systems and with other International Brands. KAVERI & SHIVA consists of a well qualified and well trained team in the field of Landscape Irrigation. It has given us an edge in the market in the current years to execute Landscape projects both large and small in size efficiently which meets international standard and also meet demands of completion of work within the mentioned period of time. Another significance is the successful completion of most number of Automated landscape Irrigation Projects in South India for the past years.

GOLF:

Our Mission is simple and that is to provide our Customers with the best service in Golf course. We are capable of prompt execution of work by utilizing smart technology that ensures satisfied customers

Every Golf irrigation product is engineered for Timeless Compatibility, allowing Client to have a state-of-the-art system that can be updated or changed without Clients existing equipment becoming obsolete.

Rain Bird offers constant field monitoring with real-time communication, allowing the system to optimize for maximum efficiency and control. Whether adjusting to unpredictable weather conditions, unexpected course challenges or catastrophic issues, real-time response keeps operating at peak levels.

EXECUTED GOLF PROJECTS

Project Name	Year
RNS Infrastructure Limited - Bangalore	2022
Karnataka Golf Association – Bangalore	2022
Turf Care LLP – Cricket and Football Ground	2022
EPGC Golf club,VIZAG	2020
JWGC Golf Course PHASE II , Mysore	2019
Birla House Cricket Ground – Bangalore	2017
Embassy boulevard	2017
Coorg Golf Links, Madikarai	2015
JWGC Golf Course PHASE I , Mysore	2015
EPGC Golf club,VIZAG	2015
Hyderabad golf association, Hyderabad	2015
Wellington Golf Club – Kunnoor	2016
KGA Group, Cochin	2007



GOLF PROJECTS - SUPPLY, SPARES & SERVICES

Project Name
Prestige Golfshire Club
Eagleton Golf Club
Bengaluru Golf Club
Palm Groove Golf Club Chennai
Eagle Burg
Bombay Presidency Golf Club
Delhi Golf Club
Zion Hills
DLF Golf & Country Club
Ooty Gymkhanna Club
Boulder Hills - Hyderabad
Tolly Gunge – West Bengal

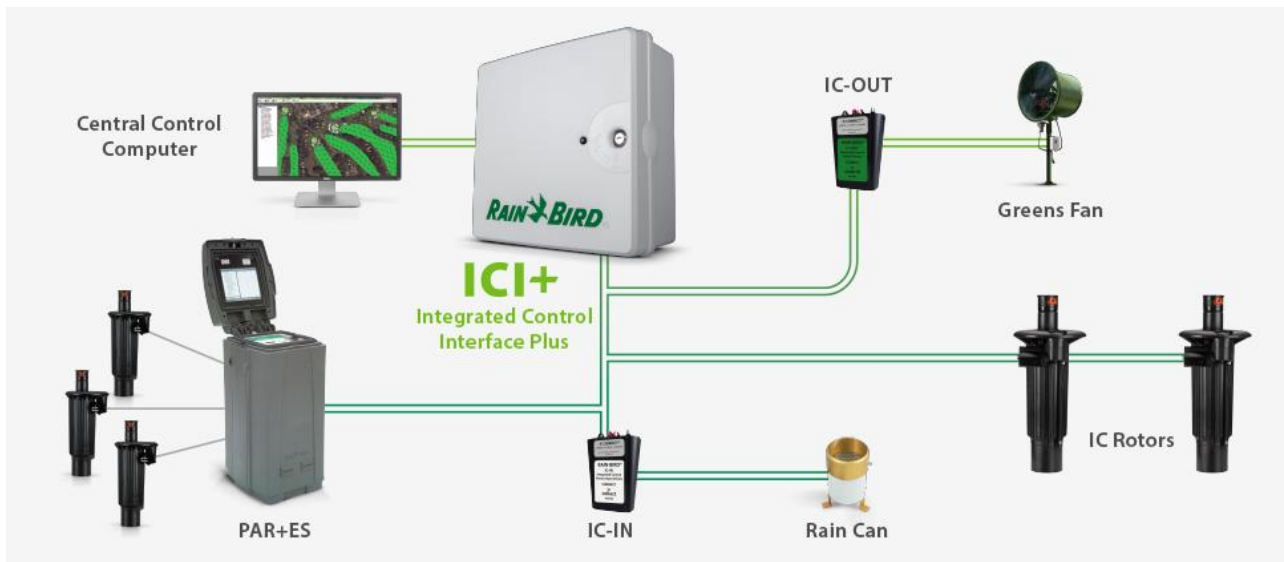

We at KAVERI & SHIVA are develop Site analysis, System Design and Execution, Equipment Specification & System Quotation, Equipment Procuring, Installation, Customer Service, Quality Assurance and also providing Sales and Services of Landscape Irrigation and Fountain Products.

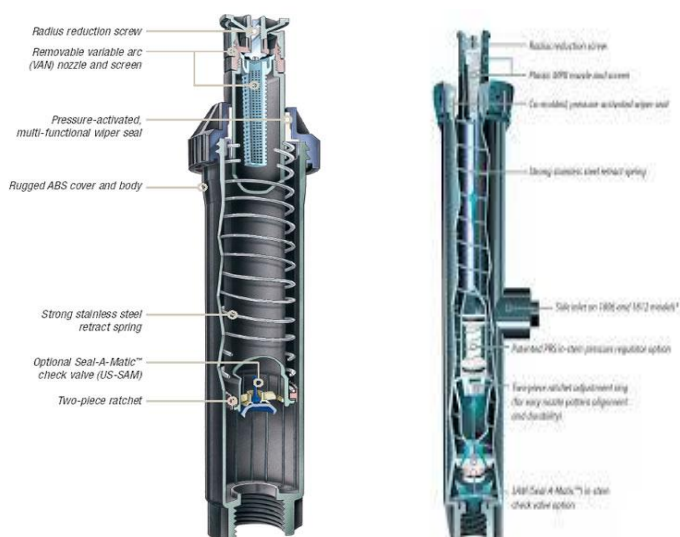

SMART IRRIGATION TECHNOLOGY

KAVERI & SHIVA systems is an established smart irrigation and fountain company run by a group of potential, experienced Engineers who have catered to the needs of the Agriculturists, Farm house owners, Planters and Industrialists.

HOW KAVERI & SHIVA WORK TOGETHER FOR CLIENTS?

Site analysis, System Design and Execution, Equipment Specification & System Quotation, Equipment Procuring, Installation, and the Customer Service and Quality Assurance and also Sales and Services of Landscape Irrigation and Fountain Product are with latest Smart Irrigation technology.

TECHNICAL DETAILS

Water - the source of life and beauty gives nourishment to the thirsty roots allowing a landscape to thrive and flourish with greenery and colorful flowers. When this water is scarce the plants tend to continuously loose water by transpiration which will result in land parches and wither away plants which ultimately wilt and die. Too much, streams and creeks flow with an angry energy that erodes the land and overwhelms the otherwise delicate landscape.

The Amount of water required by different plants varies drastically. For example, the amount of water required by Xerophytes Plant is less compared to that of a Helophytic plant.

We, KAVERI & SHIVA systems develop ideas that help you to deliver just the right amount of water, where needed and when needed. Our commitment to offer our Clients the highest quality Water Management keeps their lawn, Garden and the other like Landscapes green, healthy and blossoming with Colorful flowers.



The Advantages of using Smart Irrigation Systems are as follows:

- (i) 50% Water is saved which otherwise would go for a waste.
- (ii) Uniform and exact distribution of water.
- (iii) Reduction of labor cost
- (iv) Moreover, it gives attractiveness with elegancy to your landscape.
- (v) Controls erosion of crucial top layer of soil

In a nutshell, we offer customized Smart Irrigation Systems that are environment friendly and cuts operational costs tremendously.

RANGE OF PRODUCTS

We are proud to be associated with the world's number One Irrigation Company executing Smart Irrigation technology. The use of Rain bird products is a feather in our cap. Apart from being a World - renowned Company and pioneering water management in India, Rain bird offers Warranty and can be used for all kinds of water requirements.



LIST OF PRODUCTS

LANDSCAPE IRRIGATION

Drippers - that come in three dimensions varying in their discharge being 2, 4 and 6 LPH respectively. These emitters place one drop of water at a time. They are fully pressures compensating, Self-flushing, and resistant to agricultural chemicals and Ultra violet rays. They are applicable for Trees, Row Crops, Nurseries, Vines, Green houses, etc



Sprinkler - These use a piping system throughout the field.

The sprinklers are mounted on vertical pipes (risers) spaced equal to the radius of water throw.

Pop ups, Rotors, Spray heads, Impacts, etc are used.

MICRO IRRIGATION



Micro sprays and bubbler - installed on a stake under small to medium trees or under vines, one or two per tree or vine. This area of coverage is less than a spinner.

Micro - spinners/ Micro Quick - installed on a stake under medium to large trees, one per tree. The spinner provides greater distance of throw with low flow rates

SMART IRRIGATION SYSTEMS

1. Subsurface irrigation
2. Bubblers, sprays and ROTORS
3. RAINGUN Irrigation
4. Root water system
5. Central control irrigation system
6. Dust suppression systems
7. STP water based irrigation system
8. Moisture and rain sensor based smart irrigation system



WATER FEATURES

KAVERI & SHIVA is also proud of its association with **VARIOS FOUNTAINS**. We bring to your doorsteps wide variety of fountains, which transforms and adds further glamour to your blossoming landscape, which is a source of beauty to your gardens, industries, Resorts, Farmhouses and various other places. . Kaveri being an expert in this field has the skill and knowledge to recreate natures, water features at your fingertips.



We are specialized in indoor, outdoor and aerating fountain. Aerating fountain unlike our conventional fountain not only adds beauty but also end those multiplying water quality performance, Design, Supply & Execution of the same.

PROBLEM RESOLVER:

- Long hot summer system
- Unsightly algae blooms
- Suffocating sludge buildups
- Excessive weed growth
- Unpleasant odors
- Costly chemicals and dyes
- Oxygen deficiency
- Anaerobic bio-degradation
- Fertilizer runoff & other pollutants
- Creates brilliant, radiant water appearance
- Naturally cleans up organic

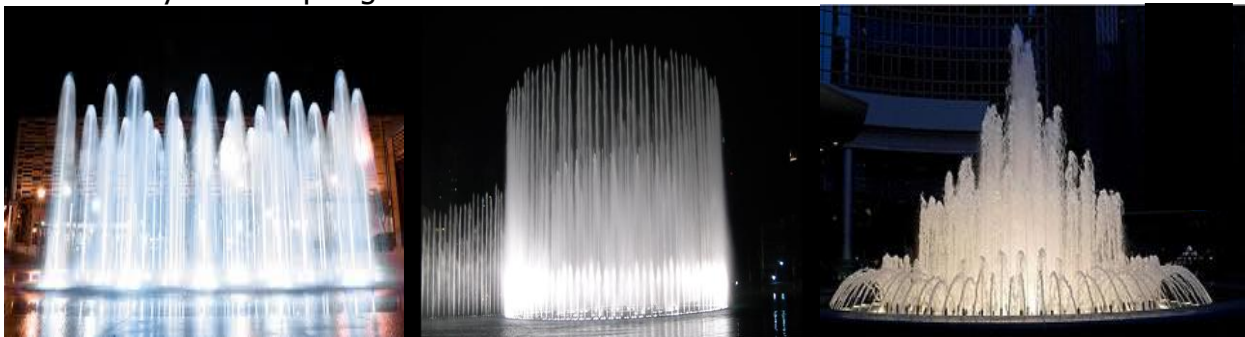

SWIMMING POOLS

KAVERI IRRIGATIONS, committed to the industry with innovative and high-performance products. Each product is selected at factory after reviewing its engineering expertise and craft with clients in mind. We also ensure strict standards for quality performance , Design , Supply & Execution of the same.

- ✓ Top Mounted Filters
- ✓ Side Mounted Filters
- ✓ Residential Pumps
- ✓ Semi Commercial Pumps
- ✓ Commercial Pumps
- ✓ Counter Current System



MIST FOG SYSTEMS

The Misting Fog systems atomize water through high pressure pumps and, particularly in hot days, they create a pleasant sensation of freshness. In addition of high pressure pumps it's necessary to take in consideration **filters, fittings, nozzles, accessories, control device** and all other components to personalize a complete **fog system**. We Design, Supply and Execute projects with Fog Systems.



KOI POND

Our Design , Supply and Consultation Service is used by many architectural landscapers and hundreds of ponds in the country have the influence of Koi pond ideas and designs. We continue to produce ponds and water features of the highest quality that require minimal maintenance.

We design our Koi ponds to be hassle-free for your long-term use. Waste is accumulated over time and is found in three types – floating debris, waste that is mixed in with the water, and sediment waste at the bottom of the Koi pond.

CUSTOMER SERVICE IS NOT A DEPARTMENT; IT'S AN ATTITUDE TOWARDS CUSTOMER TO PROVIDE DELIGHTED SERVICE!!!

We, at KAVERI offer valuable customer Service. We attend all the queries enquired by our valued customer. To enhance customer delight, we have separate team at back office to respond all clarifications enquired by our customers.

The 5 Pillars of a Good Customer Service Team



Channel variety



A proactive support team



Focus on customer satisfaction



Usage of an internal and external knowledge base



Customer Relationship Management (CRM) tools



We SHIVA EXPORTS & KAVERI IRRIGATIONS convert all your virtual imagination of Irrigation, Fountain Plan in to Smarter Visual reality , triggering a breakthrough from the conventional Design plans , Supply , Project Execution , Service after Sales thru Annual Maintenance system using modern Smart Irrigation, Water features, Mist Fog system , Swimming pool and KOI Pond system.

CONTACT US

For Placing orders : orders@shiva-kaveri.com
For Enquiries : sales@shiva-kaveri.com
For Design Enquiries : design@shiva-kaveri.com
AP team : ap@shiva-kaveri.com
Karnataka team : projects@shiva-kaveri.com
Tamilnadu team : rain@shiva-kaveri.com